

4 3 2 1

F

F

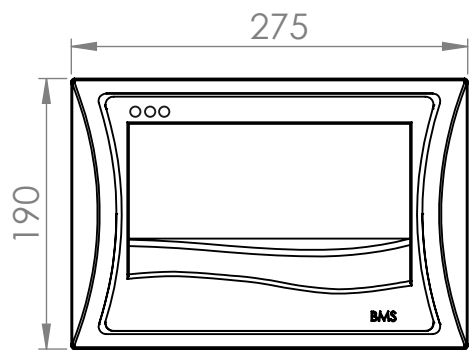
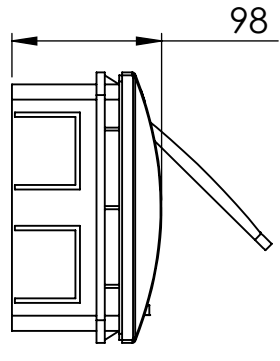

E

E

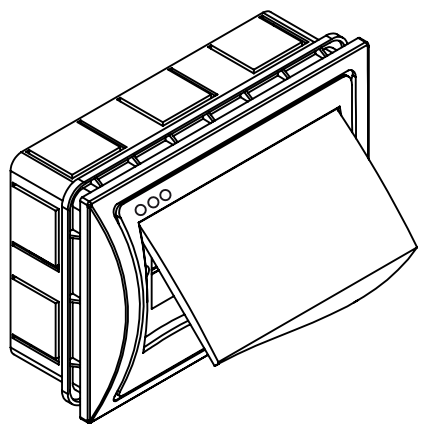

D

D

C

C

B

B

SAUF INDICATION CONTRAIRE:
LES COTES SONT EN MILLIMETRES
ETAT DE SURFACE:
TOLERANCES:
LINEAIRES:
ANGULAIRES:

FINITION:

CASSER LES ANGES VIFS

NE PAS CHANGER L'ECHELLE

REVISION

	NOM	SIGNATURE	DATE		TITRE:
AUTEUR					<h1>Assemblage tableau FEV 10</h1>
VERIF.					
APPR.					
FAB.					
QUAL.				MATERIAU:	No. DE PLAN
				MASSE:	ECHELLE:1:5

A

A4

FEUILLE 1 SUR 1

4 3 2 1